

Drawing	N.01.C.E.2.163.A	MFG	OFS	<i>Tunnel Mill Polymer, Inc.</i> 103 Main St. Po Box 23 Alden, IA 50006 Phone: 515.859.7629 Fax: 515.859.7706 Email: Sales@tunnelmill.com Website: Tunnelmill.com
Drawn By	Marcela Hoversten	Cabinet	ORBITAL 288	
Date	04/10/10	Foundation	B365406-00	
Checked By	Brian Day	Vault	U304836	
Date	00/00/00	Please check tunnelmill.com for the latest version of this drawing and for downloads in other drawing formats.		
Revision	A			
Revision Date	00/00/00			
Page	1 OF 8			

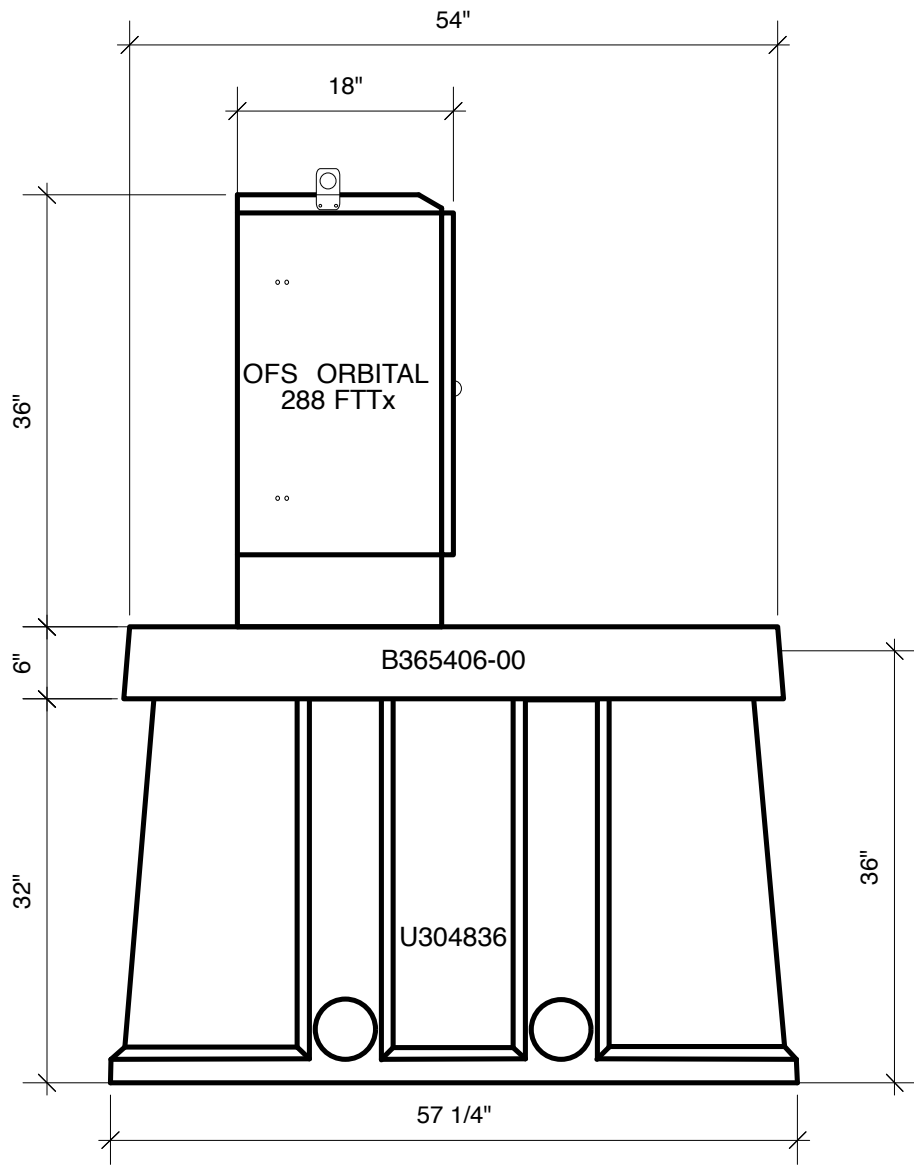

Drawing	N.01.C.E.2.163.A	MFG	OFS
Drawn By	Marcela Hoversten	Cabinet	ORBITAL 288
Date	04/10/10	Foundation	B365406-00
Checked By	Brian Day	Vault	U304836
Date	00/00/00	Please check tunnelmill.com for the latest version of this drawing and for downloads in other drawing formats.	
Revision	A		
Revision Date	00/00/00		
Page	2 OF 8		

***Tunnel Mill
Polymer, Inc.***

103 Main St.
Po Box 23
Alden, IA 50006
Phone: 515.859.7629
Fax: 515.859.7706
Email: Sales@tunnelmill.com
Website: Tunnelmill.com

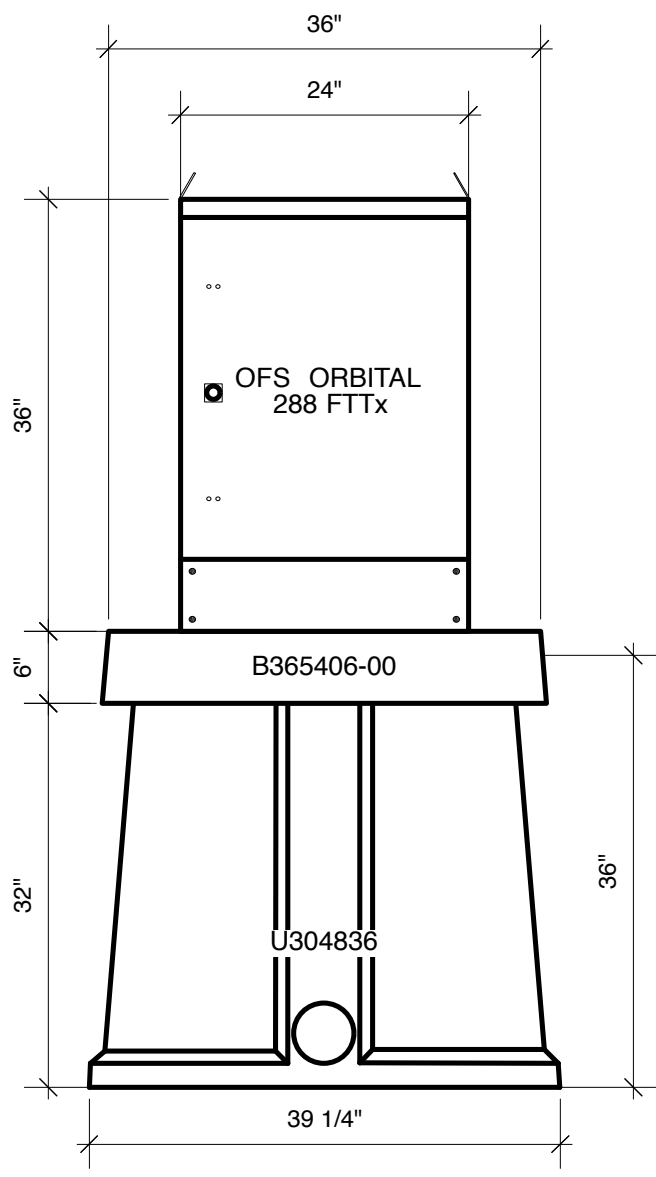

Drawing	N.01.C.E.2.163.A	MFG	OFS	<i>Tunnel Mill Polymer, Inc.</i> 103 Main St. Po Box 23 Alden, IA 50006 Phone: 515.859.7629 Fax: 515.859.7706 Email: Sales@tunnelmill.com Website: Tunnelmill.com
Drawn By	Marcela Hoversten	Cabinet	ORBITAL 288	
Date	04/10/10	Foundation	B365406-00	
Checked By	Brian Day	Vault	U304836	
Date	00/00/00	Please check tunnelmill.com for the latest version of this drawing and for downloads in other drawing formats.		
Revision	A			
Revision Date	00/00/00			
Page	3 OF 8			

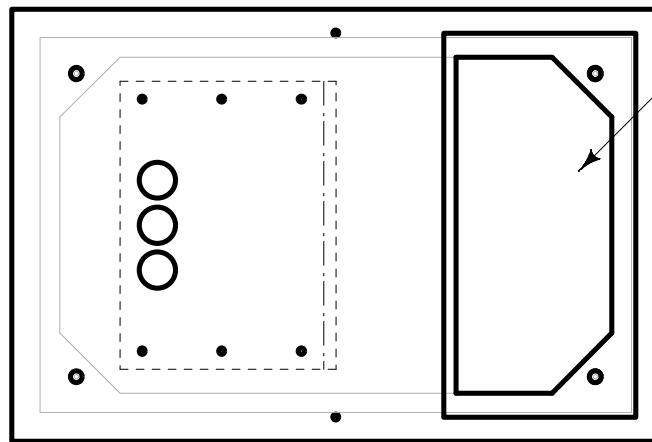

16" x 32" HATCH

Drawing	N.01.C.E.2.163.A	MFG	OFS	<i>Tunnel Mill Polymer, Inc.</i> 103 Main St. Po Box 23 Alden, IA 50006 Phone: 515.859.7629 Fax: 515.859.7706 Email: Sales@tunnelmill.com Website: Tunnelmill.com
Drawn By	Marcela Hoversten	Cabinet	ORBITAL 288	
Date	04/10/10	Foundation	B365406-00	
Checked By	Brian Day	Vault	U304836	
Date	00/00/00	Please check tunnelmill.com for the latest version of this drawing and for downloads in other drawing formats.		
Revision	A			
Revision Date	00/00/00			
Page	4 OF 8			